

MODEL 212S: SURVIVAL HYBRID STOVE
MODEL 212 VIEWS

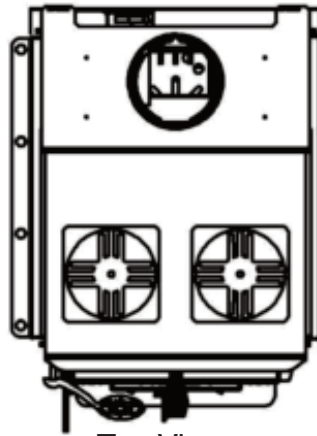

Top View

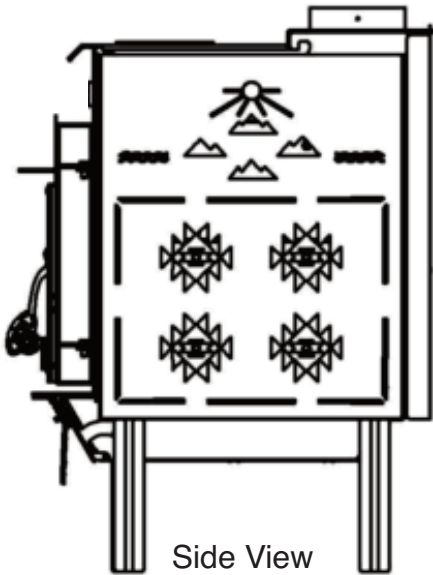
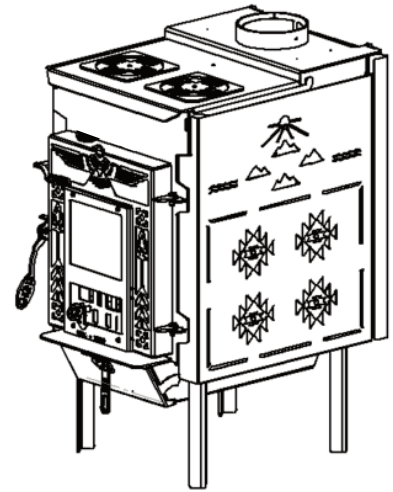

Side View

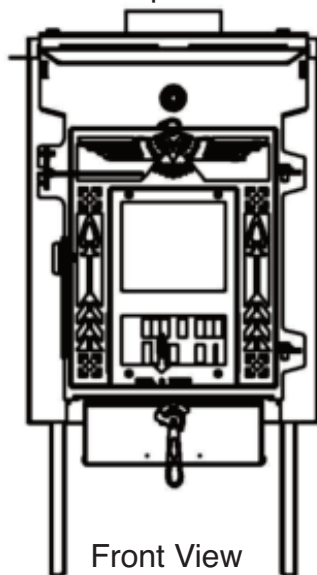

Front View

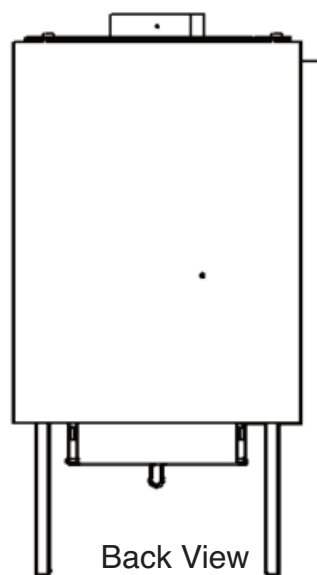

Back View

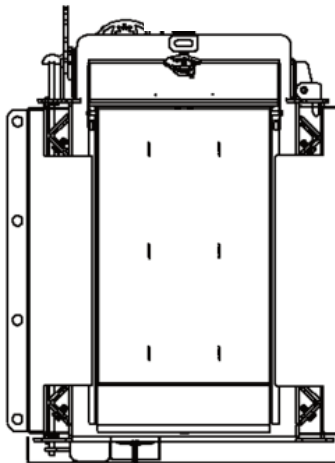

Bottom View

MODEL 212S: SURVIVAL HYBRID STOVE ASSEMBLIES

NS-2 Ash Grate	NS-12 Ash Pan Assembly
NS-3 Lift Top Assembly	NS-13 Load Door Assembly
NS-4 Bypass Rod Assembly	NS-19 Firebrick Assembly
NS-5 Tertiary Inlet/Bimetallic Assembly	NS-21 Fireback Assembly
NS-7 Heat Exchange Assembly	NS-22 Leg (4)
NS-8 Body Box	NS-25 Fixed Top Assembly
NS-10 Bypass Damper	NS-31 Catalyst: Clariant 5.83" x 2" x 49 cpsi Stainless

NS-3 Lift Top Assembly

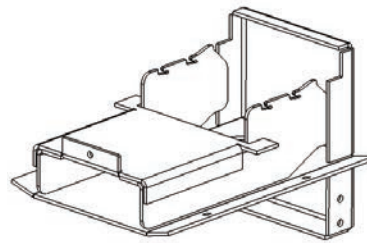
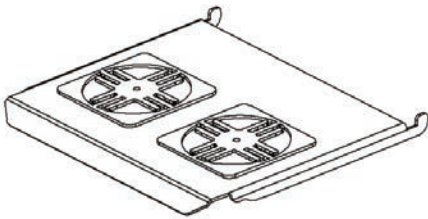

NS-7 Heat Exchange Assembly

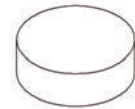

NS-31 Catalyst

NS-4 Bypass Rod Assembly

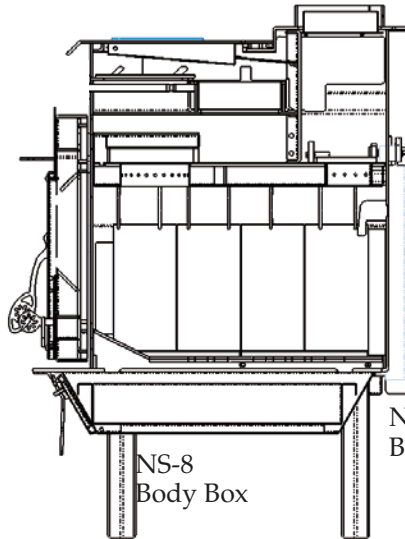
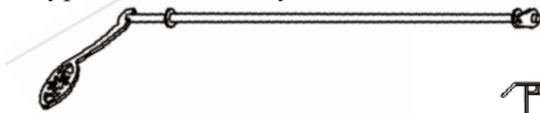

NS-8 Body Box



NS-5 Tertiary Inlet w/
Bimetallic Damper

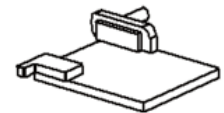

NS-10 Bypass Damper

NS-13 Load Door Assembly

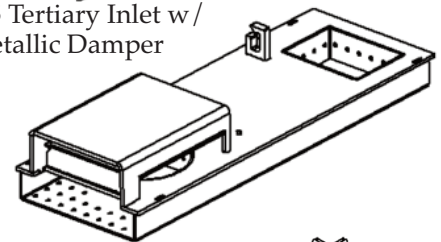
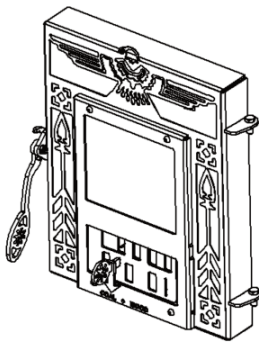

NS-21 Fireback Assembly



NS-22 Leg (4)

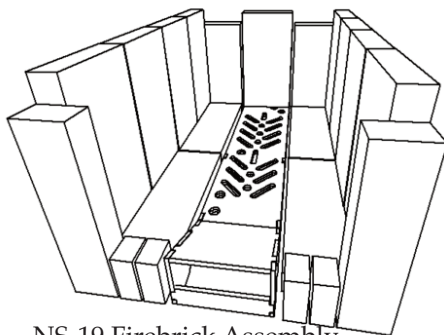

NS-19 Firebrick Assembly
NS-2 Ash Grate

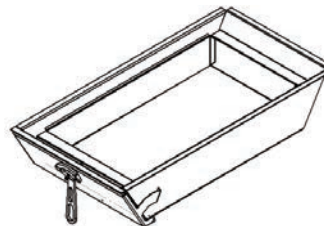

NS-12 Ash Box and Ash Pan Assembly
Welded to Body Box

- NS-18 Heat Shield Assembly
- 1. Back Shield
- 2. Left Shield / Tool Holder
- 3. Right Shield
- 4. Bottom Shield

MODEL 212S: SURVIVAL HYBRID STOVE SHIELDS AND OUTSIDE AIR ADAPTER

NS-18 Heat Shield Assembly	NS-20 Outside Air Duct
1) Back Shield	NS-23 Outside Air Front Panel
2) Left Shield	NS-24a Pipe Shield
3) Right Shield	NS-24b Ceiling Shield
4) Bottom Shield	

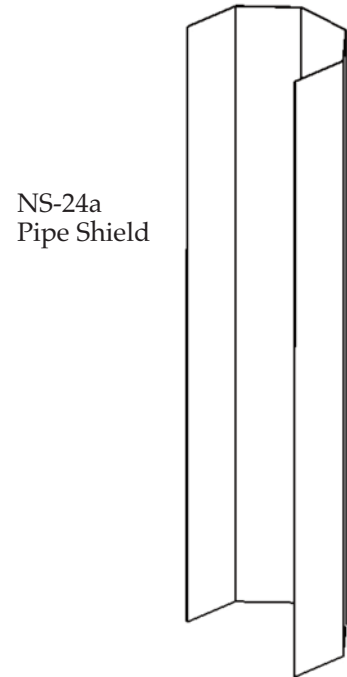
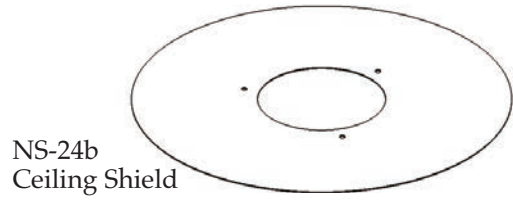
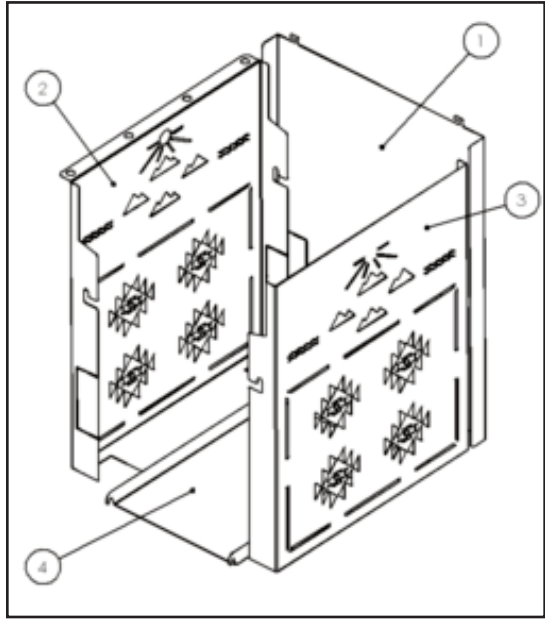
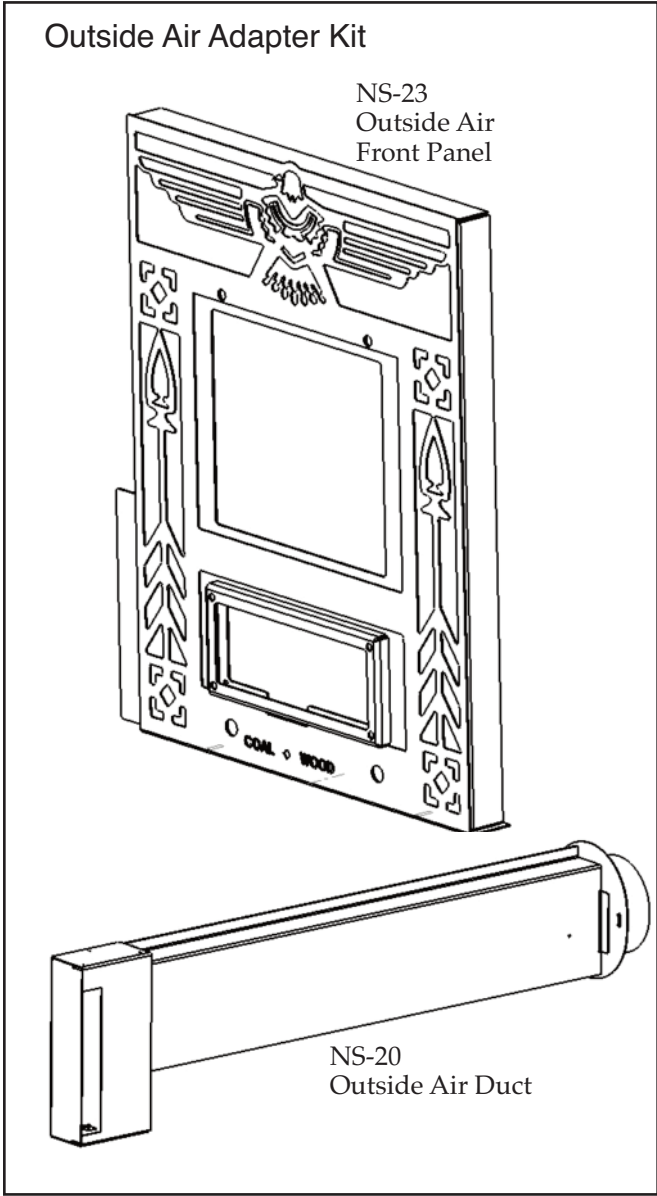

MODEL 212S: SURVIVAL HYBRID STOVES
PARTS LIST

MODEL 212	Parts List	Manufacturer
NS-2	Ash Grate	Woodstock Soapstone Co.
NS-3	Lift Top	Woodstock Soapstone Co.
NS-4	Bypass Rod Assembly	Woodstock Soapstone Co.
NS-5	Tertiary Air Inlet/Bimetallic	Woodstock Soapstone Co.
NS-7	Heat Exchange Assembly	Woodstock Soapstone Co.
NS-8	Body Box	Woodstock Soapstone Co.
NS-10	Bypass Damper	Woodstock Soapstone Co.
NS-13	Load Door	Woodstock Soapstone Co.
NS-18	Heat Shield Assembly	Woodstock Soapstone Co.
	<i>Left, right, bottom back shields</i>	
NS-19	Firebrick Assembly	Purchased Parts
		<i>4.5" x 9" x 1.25 medium duty split brick</i>
NS-20	Outside Air Duct	Woodstock Soapstone Co.
NS-21	Fireback Assembly	Woodstock Soapstone Co.
NS-22	Leg (4)	Woodstock Soapstone Co.
NS-23	OAA Front Panel	Woodstock Soapstone Co.
NS-24	Flue Shield/Ceiling Shield	Woodstock Soapstone Co.
NS-25	Fixed Top Assembly	Woodstock Soapstone Co.
NS -12	Ash Pan Assembly	Woodstock Soapstone Co.
R-54	Tertiary Damper	Woodstock Soapstone Co.
NS-31	Catalyst	Woodstock Soapstone Co. & Applied Catalyts
		<i>5.86" Dia x 2" x 49 cpsi frameless ss foil catalyst</i>
NS-906	Glass for Load Door	Purchased Part - Schott
		<i>5mm x 8" x 7" Robax</i>
	Gasket	
	Top Lid	0.875" LD x 59" Fiberglass Rope
	Side Door	0.875" LD x 70" Fiberglass Rope
	Ash Pan Door	0.500" MD BHM x 30" Fiberglass Tape
	Fireback Assembly	0.187" x 0.75" x 70" Fiberglass Tape
	Heat Exchange Assembly	0.187" x 0.75" x 42" Fiberglass Tape
	Front Window	0.187" x 0.75" x 30" Fiberglass Tape